

 **Matsura**

Vertical Machining Center

VX-1500



MAXIA
Innovation by  Matsura

Matsuura VX-1500

Advanced and Updated; The **VX-1500**. Robust, Cost Effective and Heavy Duty Cutting Performance of Billets up to 2 Tonnes.

New Fanuc 31i control, modernized, ergonomic re-styled guards and widened cutting performance via a **MAXIA** BT50 Spindle.

Table size: 1,700×700 mm (66.92×27.55 in.)

Loading Capacity: 2,000 kg (4,400 lb.)

MAXIA spindle: 15,000 min⁻¹

**Standard features:
Spindle through coolant and lift up conveyor.**



Coolant-through mechanism



Lift-up conveyor

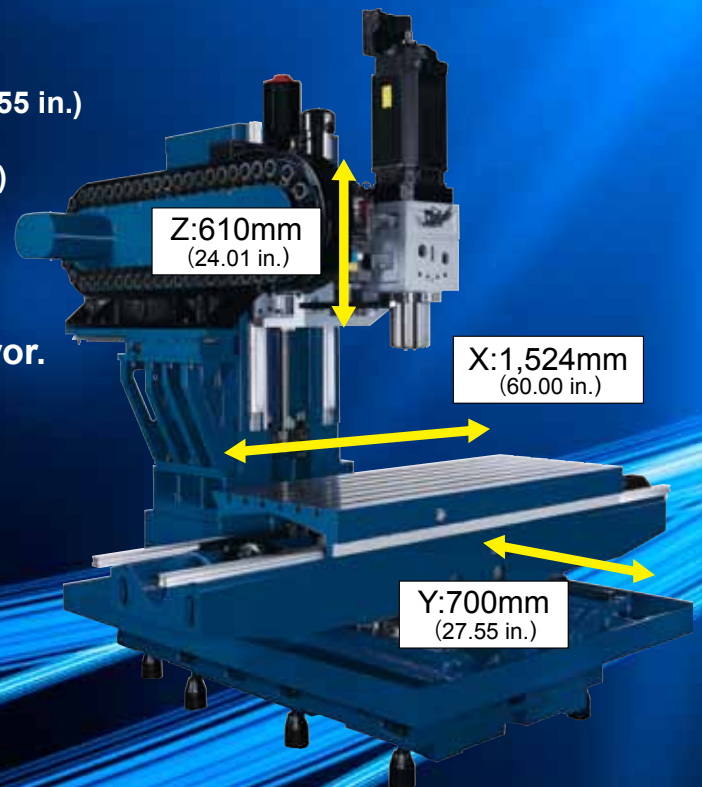

Update!



* Photo shows machine with options installed

MAXIA
Innovation by  Matsuura

Renowned **MAXIA** Spindles; BT40 15,000 min⁻¹ standard, BT50 15,000 min⁻¹ option

Fulfilling the market needs for high speed, high torque & rapid metal removal, the **MAXIA** BT40 & BT50 spindles available with the **VX-1500** are the product of many decades of **Matsuura** know how as the original pioneers of high speed spindles. Optimized functionality and sustained cutting performance as standard.

MAXIA Spindle

The **MAXIA** Spindles adhere to the very same stringent quality controls as stipulated by **Matsuura**. Hand built in a dedicated clean room environment, the **VX-1500** maintenance free auto grease 15,000 min⁻¹ **MAXIA** spindle achieves the same build accuracies and strict QA controls as all **Matsuura** spindles.



#40 Standard

Spindle Power and Torque Diagram

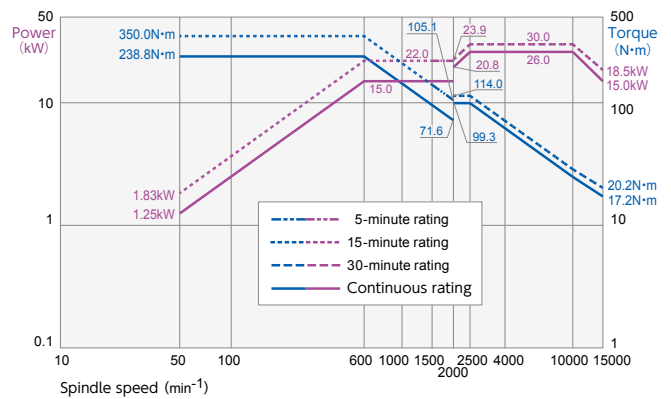





Thermal Displacement Compensation: Eliminate Errors from Spindle Growth.

The **MAXIA** spindle possesses a tried and tested Thermal Displacement function that eliminates machining errors due to thermal growth of the machine - offering long periods of stable, reliable and accurate operation even if the machining environment ambient temperature excessively fluctuates.

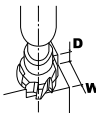
Spindle specifications		
Taper	# 40 Standard	# 50 Option
Spindle speed	15,000	15,000
Bearing diameter (mm)	D80 (3.14 in.)	D90 (3.54 in.)
Power (kW)	15 / 30	15 / 30
Torque (N·m)	350.0	350.0
Lubrication system	Automatic grease supply	Oil/air

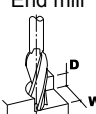
■ Cutting test results (BT40 15,000min⁻¹)

	Work material	Tool	Cut width Cut depth	Spindle rotation speed	Cutting feed rate	Cutting amount		Work material	Tool	Spindle rotation speed	Cutting feed rate	Work material
	Aluminum	Ø80mm (3.14) 3 blades	W=70mm (2.75) D=5mm (0.19)	5,500 min ⁻¹	11,000 mm/min (433.07)	3,850 cc/min		Aluminum	Ø35mm (1.37)	1,500 min ⁻¹	800 mm/min (31.49)	769 cc/min
	Steel	Ø125mm (4.92) 9 blades	W=100mm (3.93) D=5mm (0.19)	550 min ⁻¹	880 mm/min (34.64)	440 cc/min		Steel	Ø35mm (1.37)	1,300 min ⁻¹	330 mm/min (12.99)	317 cc/min
	Aluminum	Ø25mm (0.98) 2 blades	W=22mm (0.86) D=10mm (0.39)	10,000 min ⁻¹	10,000 mm/min (393.70)	2,200 cc/min		Aluminum	M42 × P4.5	100 min ⁻¹	450 mm/min (17.71)	
	Steel	Ø20mm (0.78) 4 blades	W=3mm (0.11) D=35mm (1.37)	5,500 min ⁻¹	6,500 mm/min (255.90)	683 cc/min		Steel	M42 × P4.5	100 min ⁻¹	450 mm/min (17.71)	

*Results above may differ in repeat tests due to different operating conditions.



#50 spindle Option

■ Measurement results verifying high accuracy

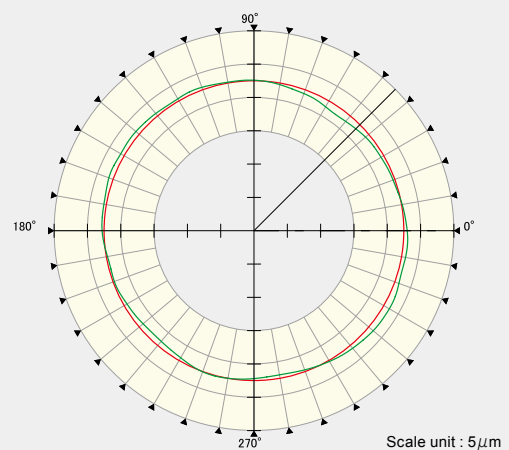

Roundness
2.14 μm
* Actual value

Filter	1-15
Material	Aluminum A5052
Spindle rotation speed	5,000 min ⁻¹
Feed rate	1,000 mm/min(39.37 ipm)
Tool	2-blades end mill

* The measurement results are actual values but not guaranteed values.

Expanded BT40 ATC; 60 Tool Stations for Diversified Machining Versatility

Standard tool capacity for the BT40 toolholder is 48 stations, with 60 available as an option. The BT50 toolholder ATC has capacity for 30 tools.

Automatic tool changer

“Memory random system” adopted, shortening time to select the next tool

■ Standard drum magazine for 48 tools



■ Maximum tool size mm (in.)

#40

⟨With adjacent tools⟩

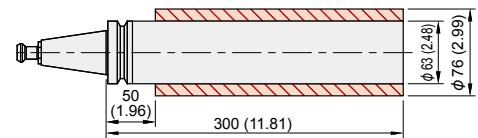

⟨With no adjacent tools⟩

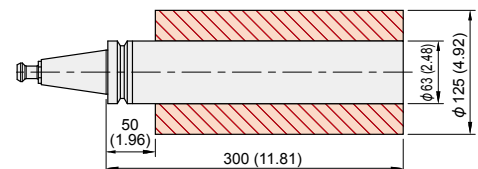

#50

⟨With adjacent tools⟩

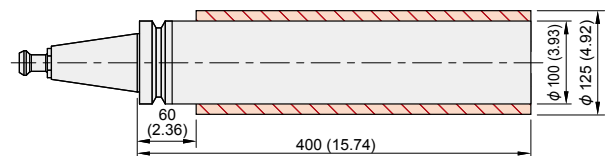

⟨With no adjacent tools⟩

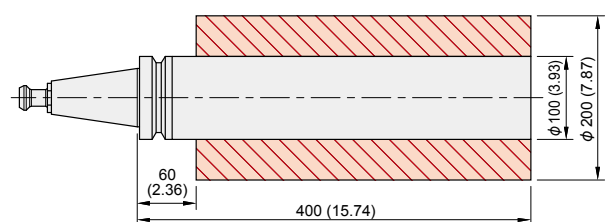

Classic **Matsuura** Machine Build; Attention to Detail and Commitment to Engineering Excellence

Matsuura; Technology Innovators & Historical Creators of Vertical Machining Centers

Ergonomic design, operator comfort and safety: The **VX-1500** has it all.

The **VX-1500** is designed to maximise operator comfort and increase production output. Simple touches such as the remote manual pulse generator and a cavourness opening of 1,700mm gives the operator ease of use and reduce set up time.

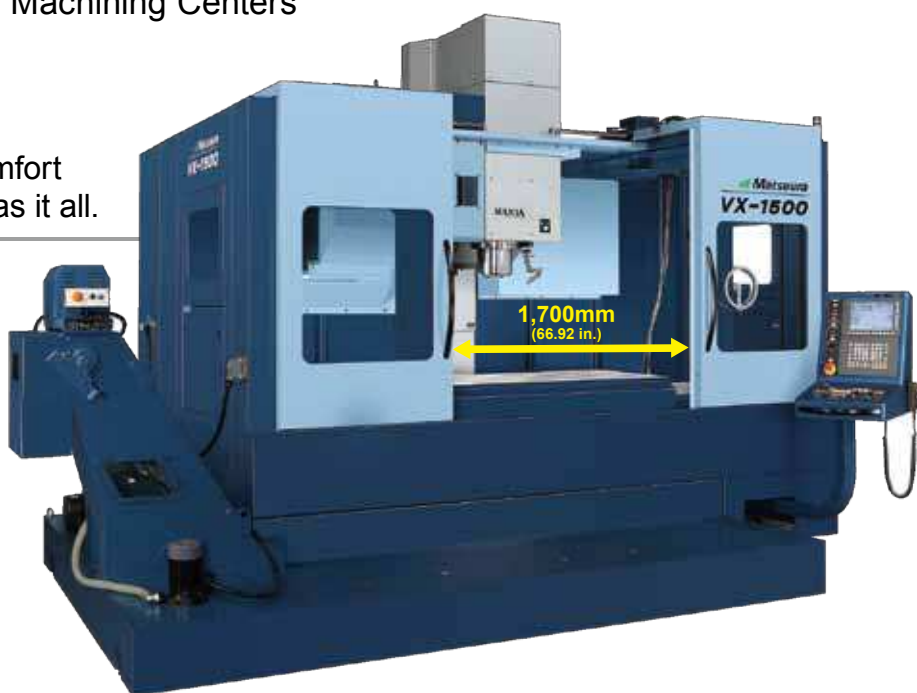

High-precision positioning

High precision and rigidity are standard features of all ballscrews and linear guides - offering dynamic and repeatable performance over many years of operation.

Positioning accuracy of each axis

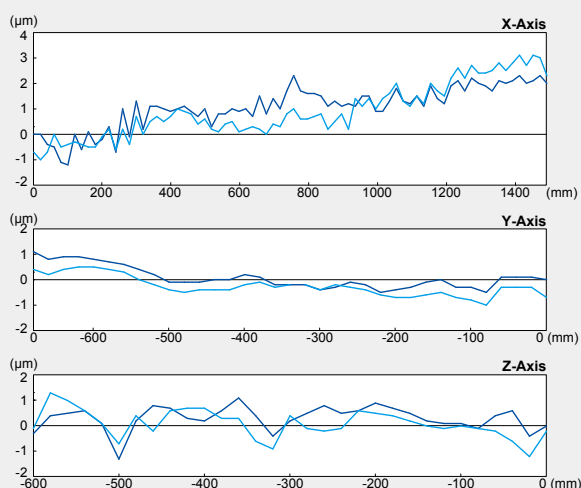

* The measurement results are actual values but not guaranteed values.

Standard specifications

Movement and Ranges (X/Y/Z axis)	mm (in.)	1,524 / 700 / 610 (60.00 / 27.55 / 24.01)
Working Surface	mm (in.)	1,700 × 700 (66.92 × 27.55)
Loading Capacity	kg (lb.)	2,000 (4,400)
Rapid traverse rate (X/Y/Z axis)	m/min (in.)	36 / 36 / 36 (1417.32 / 1417.32 / 1417.32)

Dedicated & Focussed on Operability, Functionality & Ease of Use

VX-1500; a consummate performer, no matter what the task,
no matter what the material

Excellent Swarf Management

Modern machine shops and production environments require proven swarf management. Downtime due to blocked conveyors and "swarf traps" because of poor machine design are unacceptable as manufacturers lessen their time to market and improve cost per part ratios. The **VX-1500** inherits all of the design success of previous **Matsuura** machines and their proven swarf management design systems.

- Chip flush
- Spiral chip conveyor
- Air Blow for Chip Removal

- Lift-up conveyor
- Lift-up conveyor (with drum filter) **Option**

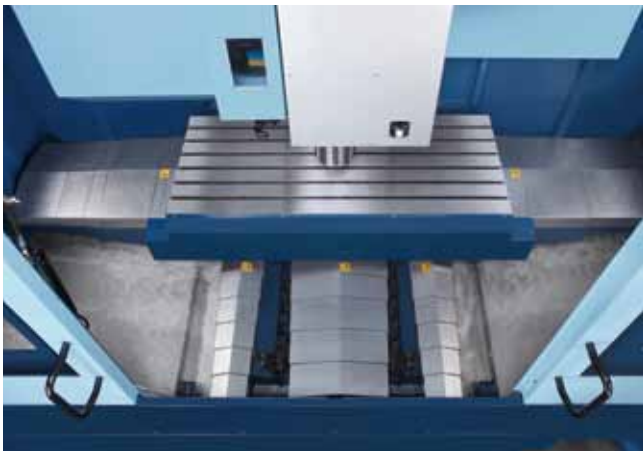

- Coolant-through Spindle System

- Workpiece cleaning gun



MIMS Matsuura Intelligent Meister System

Combining craftsmanship, skill and ingenuity

Matsuura's original interface with uncompromising pursuit of utility

Environment

Eco Meister

Power savings

- Power cut-off function

Simple

Operability Meister

Hassle-free, simple operation

- Tool setup support
- Workpiece setup support
- Restart after machining stop

Accuracy

Thermal Meister

Stable accuracy

- Spindle thermal displacement compensation

Secure

Reliability Meister

Reduced machine downtime

- Preventive maintenance support function
- Machine recovery support function

Reliability Meister Plus

Offering greater peace of mind

- Electronic manual function
- Mail transmission function

Selectable M Codes

Matsuura original M codes now selectable

Function	Matsuura M code	VX M code
Through-spindle coolant start	M50	M11
Air blow for chip removal start/stop	M25/ 27	M12/ 32
Rigid tap mode preparation	M80	M29
4th-axis clamp	M21	M43
Orientation start for automatic measurement	M59	M109
Air blow start/stop Tool breakage detection sensor	M63/ 64	M47/ 48
Automatic measurement ON/OFF	M108/ 109	M58/ 85
Operator door open/close	M78/ 79	M138/ 139

* Can be changed by parameter.

Operation panel

Operation panel changed for improved operability



Standard Machine Specifications

■ Movement and Ranges		
X-Axis Travel	mm (in.)	1524 (60.00)
Y-Axis Travel	mm (in.)	700 (27.55)
Z-Axis Travel	mm (in.)	610 (24.01)
Table Surface to Spindle Gauge Line	mm (in.)	150 - 760 (5.90 - 29.92)
Table Center to Column Guideway	mm (in.)	435 - 1135 (17.12 - 44.68)
Spindle Center to Column Guideway	mm (in.)	785 (30.9)
■ Table		
Working Surface	mm (in.)	1700 X 700 (66.92×27.55)
Loading Capacity	kg (lb.)	2000 (4400)
Working Surface Configuration (width × number × pitch)	mm (in.)	18 (0.7) × 6 × 100 (3.93)
Table Height (from floor)	mm (in.)	1039 (40.90)
■ Spindle		
Spindle Speed Range	min ⁻¹	50 - 15000 (Grease Lubrication)
Spindle Speed Change Command		S5-digit Direct Command
Spindle Taper		7/24 Taper JIS BT40 (Double Contact Type)
Spindle Bearing Inner Dia.	mm (in.)	80 (3.14)
Max. Spindle Torque	N · m	350 / 600min ⁻¹
Spindle Air Blow		Standard
Spindle Orientation		Standard (Electrical)
Tool Clamping Force	kN	12.0
■ Feedrate		
Rapid Traverse Rate X / Y / Z	mm/min (ipm)	36000 (1417.32)
Feedrate X / Y / Z	mm/min (ipm)	1 - 20000 (0.1 - 787.4) Limited to maximum cutting feed rate of the z-axis if simultaneous 2-axis (X/Z and Y/Z) or 3-axis (X/Y/Z) interpolation command is executed.
Jog Feedrate	mm/min (ipm)	0-4000 (0-157.48)
Min. Movement Increment X / Y / Z	mm (in.)	0.001 (0.000039)

■ Automatic Tool Changer		
Type of Tool Shank		JIS B 6339 Tool Shank 40T
Type of Retention Knob		JIS B 6339 Pull Stud 40P
Number of Tools		48
Max. Tool Diameter	mm (in.)	76 (2.99)
Max. Tool Diameter	mm (in.)	125 (4.92) (When the pockets on both side are empty)
Max. Tool Length	mm (in.)	300 (11.81)
Max. Tool Mass	kg (lb.)	7 (15.4)
Tool Selection		Memory Random
Tool Change Arm		Double Grip Type
Tool Pocket Pitch	mm (in.)	76.2 (3.0)
■ Motors		
Spindle Motor	kW	AC 15 / 22 (low-speed winding: continuous/40 %)
	kW	AC 26 / 30 (high-speed winding: continuous/30 min)
Feed Motors		
X-Axis	kW	AC 4.0
Y-Axis	kW	AC 4.0
Z-Axis	kW	AC 7.0
Coolant Pump Motor	kW	AC 0.6 / 1.04 (50Hz / 60Hz)
Chip Flush Pump Motor	kW	AC 2.2 / 2.5 (50Hz / 60Hz)
Oil Cooler Pump Motor	kW	AC 0.75
■ Power Supply		
Electrical Power Supply	kVA	42 (varies with option configuration)
Power Supply Voltage	V	AC 200 / 220 ± 10% Transformer required if supply voltage is other than above
Power Supply Frequency	Hz	50 / 60 ± 1
Compressed Air Supply	MPa	0.54 - 0.93
■ Tank Capacity		
Coolant Tank Capacity	L	600
Oil Cooler Tank Capacity	L	36

Table top view Unit: mm (in.)

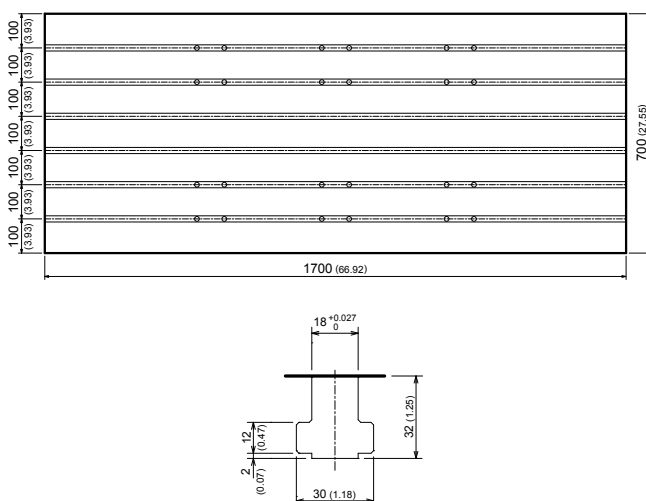

Floor plan Unit: mm (in.)

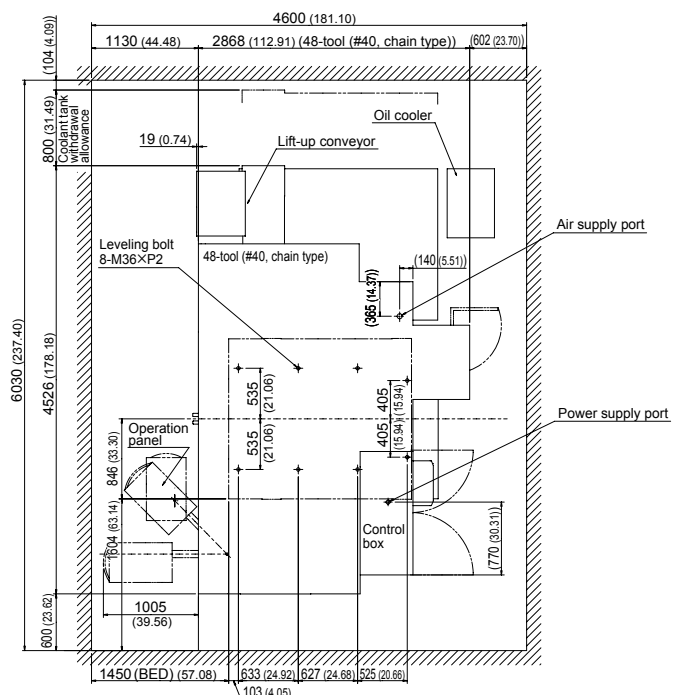

Machine Option

Machine Size		
Machine Height (from floor)	mm (in.)	3350 (131.88)
Required floor space (including maintenance area)	mm (in.)	6030W × 4600D (237.40W × 181.10D) (varies with option configuration)
Mass of Machine	kg (lb.)	9500 (20900) (include NC Equipment and ATC Magazine)
NC System		
Control System		Matsura G-Tech 31i
Standard Accessories		
01. Total Enclosure Guard	With Top Side Cover	
02. ATC Magazine Guard		
03. CE Markings		
04. Synchronized Tapping Function		
05. Spindle Oil Cooler		
06. Lift-up Chip Conveyor (Scraper)		
07. Air Blow for Chip Removal		
08. Workpiece Cleaning Gun		
09. Coolant-through Spindle System		
10. Spindle Thermal Displacement Compensation, 15k, BT40, Temperature Monitor Type		
11. Chip Flush System		
12. Coolant System	Chip Side Discharge	
13. Auto Oil Supply Unit for Feed Axes	Greasing Points with Female Ball Screws (X/Y/Z)	
14. Work Light		
15. 3-color signal light		
16. External Manual Pulse Generator		
17. Tools and Tool Box		
18. Machine Color Paint		
19. MIMS		
20. AD-TAP function		
21. IPC function		
22. Spindle overload protection		
23. M code counter (9 types)		
24. Spindle runhour meter (within the MIMS screen)		
25. Automatic operation runhour meter (within the MIMS screen)		
26. Leveling Bolts and Leveling Plates	Not for Foundation	
27. Memory card program operation and editing	CD-ROM	

* 2 years spindle warranty

Spindle
15,000min ⁻¹ (BT50 Oil-air Lubrication)
ATC
60 Tools (#40 Chain Magazine)
30 Tools (#50 Chain Magazine)
Scale Feedback System
Scale Feedback System X/Y/Z (HEIDENHAIN)
Coolant-through Spindle System
Oil Temperature Controller with 50-BAR Coolant-through System of Mono-block Construction 70 bar, supporting through-spindle coolant system
Chip Removal
Coolant Temperature Controller with 100-liter Tank (Separately Installed, Small Size) Lift-up conveyor (with drum filter)
Automatic Measurement, Tool Breakage Detection
Automatic Measurement / Automatic Alignment (Optical)
Tool Breakage / Full Automatic Tool Length Measurement (Contact)
Tool Breakage / Full Automatic Tool Length Measurement (Laser)
Automatic Measurement (Optical) / Tool Breakage (Contact)
Automatic Measurement (Optical) / Tool Breakage (Laser)
Rotary Wiper
Rotary Wiper

* Optional accessories in a wide variety are available in addition to the above. For details, contact your Matsuura representative.

External view Unit: mm (in.)

Front view

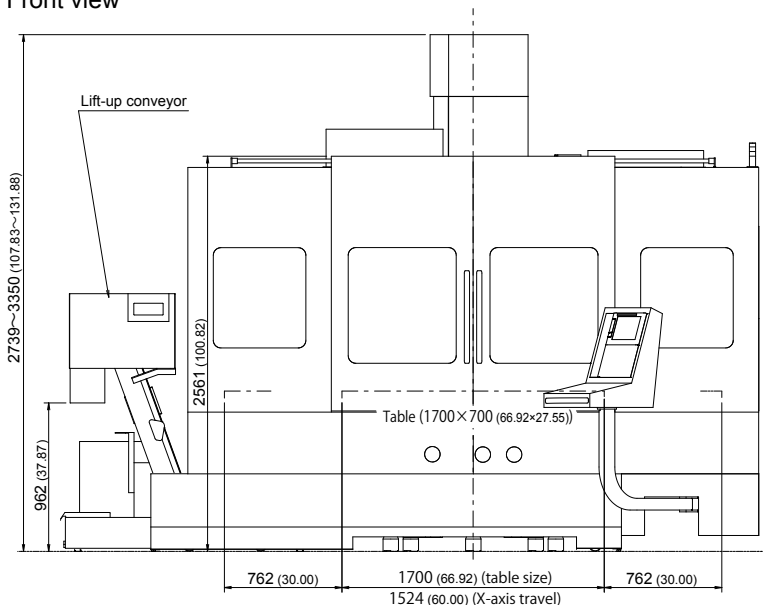

Right side view

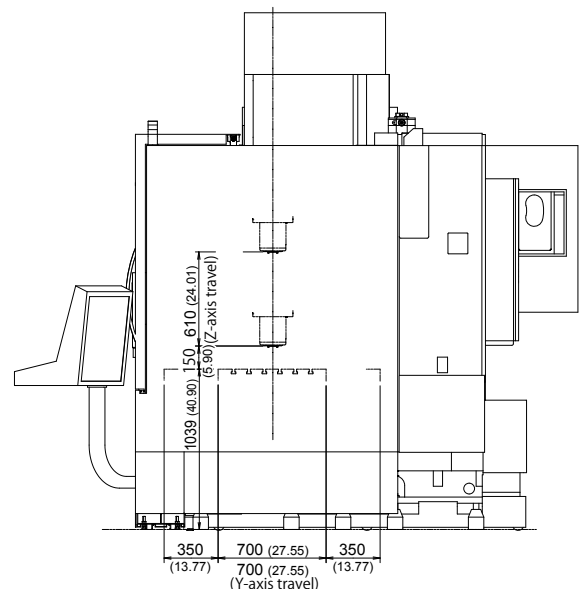



Matsuura

URL : <http://www.matsuura.co.jp/>

E-MAIL : webmaster@matsuura.co.jp

MATSUURA MACHINERY CORPORATION

1-1 Urushihara-cho Fukui City 910-8530, Japan

TEL : +81-776-56-8106 FAX : +81-776-56-8151

MATSUURA EUROPE GmbH

Berta-Cramer-Ring 21

D-65205 Wiesbaden-Delkenheim, Germany

TEL : +49-6122-7803-80 FAX : +49-6122-7803-33

URL : <http://www.matsuura.de/>

E-MAIL : info@matsuura.de

MATSUURA MACHINERY Ltd.

Gee Road, Whitwick Business Park, Coalville Leicestershire, LE67 4NH, England

TEL : +44-1530-511-400 FAX : +44-1530-511-440

URL : <http://www.matsuura.co.uk/>

E-MAIL : sales@matsuura.co.uk

Facebook : www.facebook.com/pages/Matsuura-Machinery-Ltd/427006380682983

MATSUURA MACHINERY GmbH

Berta-Cramer-Ring 21

D-65205 Wiesbaden-Delkenheim, Germany

TEL : +49-6122-7803-0 FAX : +49-6122-7803-33

URL : <http://www.matsuura.de/>

E-MAIL : info@matsuura.de

ELLIOTT MATSUURA CANADA INC.

2120 Buckingham Road Oakville Ontario L6H 5X2, Canada

TEL : +1-905-829-2211 FAX : +1-905-829-5600

URL : <http://www.elliottmachinery.com/>

E-MAIL : sales@elliottmachinery.com

MATSUURA MACHINERY USA INC.

325 Randolph Ave., St.Paul, MN 55102, U.S.A.

TEL : +1-651-289-9700

URL : <http://www.matsuurausa.com/>

E-MAIL : info@matsuurausa.com

-
- Product specifications and dimensions are subject to change without prior notice.
 - The photos may show optional accessories.



This product is subject to all applicable export control laws and regulations

